

OWNER'S MANUAL

ButtKicker[®]

Power Amplifier BKA300-4

Wireless Amplifier with Remote Control





Please record the serial number on the rear panel of your amplifier for easy reference.

Serial Number:

BKA300-

ButtKicker[®]

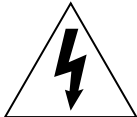
Feel what you've been missing...

	CAUTION RISK OF ELECTRIC SHOCK DO NOT OPEN	
CAUTION: TO REDUCE THE RISK OF ELECTRIC SHOCK, DO NOT REMOVE COVER (OR BACK) NO USER-SERVICEABLE PARTS INSIDE REFER SERVICING TO QUALIFIED SERVICE PERSONNEL		

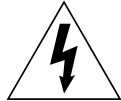

The lightning flash with arrowhead symbol within an equilateral triangle, is intended to alert the user to the presence of uninsulated "dangerous voltage" within the product's enclosure that may be of sufficient magnitude to constitute a risk of electric shock to persons.







The exclamation point within an equilateral triangle is intended to alert the user to the presence of important operating and maintenance (servicing) instructions in the literature accompanying the product.

WARNING TO REDUCE THE RISK OF FIRE OR ELECTRIC SHOCK, DO NOT EXPOSE THIS APPLIANCE TO RAIN OR MOISTURE.
CAUTION: TO PREVENT ELECTRIC SHOCK, MATCH WIDE BLADE OF PLUG TO WIDE SLOT, FULLY INSERT.

This device complies with Part 15 of the FCC Rules. Operation is subject to the following two conditions:

- (1) This device may not cause harmful interference, and
- (2) This device must accept any interference received, including interference that may cause undesired operation. Changes or modifications not expressly approved by the party responsible for compliance could void the user's authority to operate the equipment.

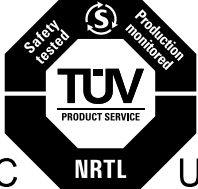
This Class B digital apparatus complies with Canadian ICES-003.
Cet appareil numérique de la classe A est conforme à la norme NMB-003 du Canada.

 RoHS Compliant	<p>This Amplifier Proudly Uses BASH Technology.®</p>  U.S. Patent # 5,075,634 and 5,510,753 Patent Pending	
 TUV PRODUCT SERVICE C NRTL US		

Amplifier Specifications

Dimensions: 8.25" L x 9.25" W x 3.5" H
Weight: 4.6 lbs./2 kgs.
Power Output: 300 watts rms @ 4 ohms / 150 watts rms @ 2 ohms
120V / 240V - Convertible
Frequency Response: 10 - 300Hz
Input Sensitivity: 100 mVolt

Wireless Specifications

Frequency: 2.4 GHz ISM band, FHSS
Usage: Worldwide
Range: Approx. 30' (9m) in normal / home environment

Included Accessories:



Remote Control



RF Transmitter



RF Receiver



*(1) RCA "Y" Adaptor
(1) 1m RCA male to male cable
(1) Speaker Level Interface Adaptor (for use with passive subwoofer systems)*



AC Power Cord



Base Stand



AC Adaptor

Contents.....Page Number

Important Safety Instructions.....01

Amplifier Warnings / Cautions.....02

Amplifier Specifications.....03

Wireless Specifications.....03

Included Accessories.....03

Amplifier Operation.....05

 Rear Panel Operation.....05 - 06

 Front Panel Operation.....07

Amplifier Setup.....08 - 10

 Wireless RF Receiver / Transmitter Setup.....08

 RF Receiver / Transmitter Wireless Connection Setup.....09 - 10

 Optional Base Stand Usage.....09

Remote Control.....11

Contact Information.....Back Cover

Warranty.....Back Cover

Amplifier Operation

Rear Panel



Rear Panel Operation - (From Left to Right)

SPEAKER OUTPUT BINDING POSTS

Power amplifier bridged output. Used for attaching speaker wire to the ButtKicker® Advance or other ButtKicker® brand low frequency audio transducers or other speakers. Turn the amplifier off before connecting to the Speaker Output. Wire sizes of 14 gauge and larger are recommended. Binding posts will accept banana type connectors as well as bare wire.

IR OUT/IN

Use for daisy chaining multiple BKA300-4 units together so that one Remote Control can control all units simultaneously. Use a cable with either a mono or stereo mini jack connector (not included) to connect one BKA300-4's IR "out" to the next BKA300-4's IR "in" and so forth.

RF RECEIVER

This input is for the RF Receiver unit and uses a USB style connector but only accepts the BKA300-4 RF Receive unit. See page 8 for Wireless Setup.

LINE OUT/IN

RCA/phono jacks. The Line In should be used for the preamp output of a consumer home theater surround processor or stereo preamp with nominal signal levels of 100mVolt. The Line Out may be used to daisy-chain multiple amplifiers together for *input signal purposes only*. [NOTE: To control multiple amplifiers with one Remote Control the IR "in" and "out" will also have to be daisy chained together as per "IR OUT/IN" above.]

VOLTAGE SELECTOR

This amplifier can be converted from a 115V to a 230V for either North American, or European use. Make sure the amplifier is powered off and the cord unplugged before changing the voltage.

WARNING: YOU MUST REPLACE THE ACTIVE FUSE WITH THE PROPER FUSE [SEE SPECIFIC TYPES BELOW UNDER 'FUSE HOLDER' (NOT INCLUDED)] WHEN CONVERTING THE VOLTAGE OF THIS AMPLIFIER. FAILURE TO DO SO WILL RESULT IN DAMAGE TO THE AMPLIFIER AND WILL VOID THE WARRANTY.

POWER CONNECTOR

Used to connect the supplied power cable to the amplifier.

CAUTION - you must use the supplied cable to avoid potential safety hazards. Also, for added protection, the amplifier may be plugged into a surge protector rather than directly into the outlet.

WARNING - DO NOT PLUG AMPLIFIER INTO ANY TYPE OF POWER CONDITIONER.

FUSE HOLDER (INTEGRATED INTO THE POWER CONNECTOR)

120V Fuse: T3.15AL 250V for 120V 50/60Hz AC input.

220 - 240V Fuse: T1.6AL 250V 50/60Hz AC input.

A spare fuse of the same type is also contained in the fuse holder for your convenience. Pull straight out after removing the power cord. Both the active fuse and the spare fuse are removed.

Amplifier Operation

Front Panel



Front Panel Operation (From Left to Right)

INFRARED RECEIVER (IR EYE)

Used to receive line of sight commands from the Remote Control for remote operation of the Amplifier. [Note: When the Wireless RF Transmitter and Send units are used, the Remote Control only needs to be able to “see” the RF Transmitter and not the Infrared Receiver on the Amplifier allowing the Amplifier to be placed in a non-visible location.]

POWER BUTTON

The Power Button connects the AC line to the amplifier circuits (i.e. turns the amplifier “on”). Check all amplifier connections and verify the AC line power source before engaging the Power Button.

POWER STATUS INDICATOR (Tri-Color LED)

When the LED is “red” it indicates that the Amplifier is plugged into a power source. A “green” LED indicates that the Amplifier has been turned on either by using the Power Button on the front panel or the “On/Off” button on the Remote Control. If the Amplifier does not receive audio signal for more than 60 minutes the Amplifier will go into “stand-by mode” and the LED will turn “yellow”. Once the amplifier receives audio signal again the LED will turn “green”. If the Amplifier is turned off the LED turns “red”.

INTENSITY CONTROL

Controls the output level of the Amplifier (i.e. the “volume” control). Set this to balance the ButtKicker® Advance with the sound system when using the amplifier to power the ButtKicker® Advance.

Amplifier Setup

Wireless RF Receiver / Transmitter Setup

Step 1.

Plug the RF Receiver unit into the "RF Receiver" input on the back of the Amplifier. The green light on the side of the RF Receiver indicates that the unit is powered on **(See Figure 1)**.

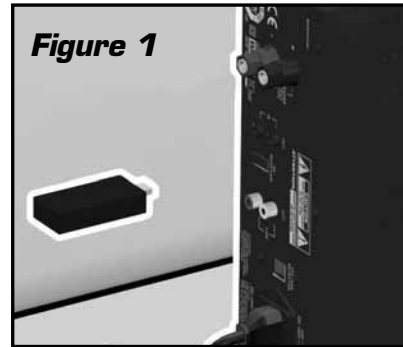

Step 2.

Connect the included AC adapter into the back of the RF Transmitter and plug into a power outlet. Connect the RF Transmitter to the "sub out" or "LFE out" pre-amp output on your A/V processor using the included RCA "Y" adaptor and 1m RCA male to male cable **(See Figure 2)**. If you want to connect both your subwoofer and the Amplifier to your system use the included "Y" adaptor. Use the included "Speaker Level Interface Adaptor" to connect to push type passive subwoofer connectors on an A/V processor. Use the included 1m RCA male to male cable to position the RF Transmitter so that it faces towards the location of the Amplifier (line of sight is NOT required). The RF Transmitter has stereo RCA inputs. Use either a single mono or dual stereo RCA input(s) from the signal source (i.e. your A/V processor).

NOTE: Stereo inputs are "summed" to mono in the RF Transmitter.

When using the Amplifier's "Wireless Setup", the RF Transmitter also communicates the Remote Control's commands to the Amplifier. Therefore make sure that the RF Transmitter is positioned so that the Remote Control can be operated WITH line of sight to the RF Transmitter. This allows the Remote Control to control the Amplifier's operation even when the Amplifier is in a non-visible position (such as behind a couch or another piece of furniture).

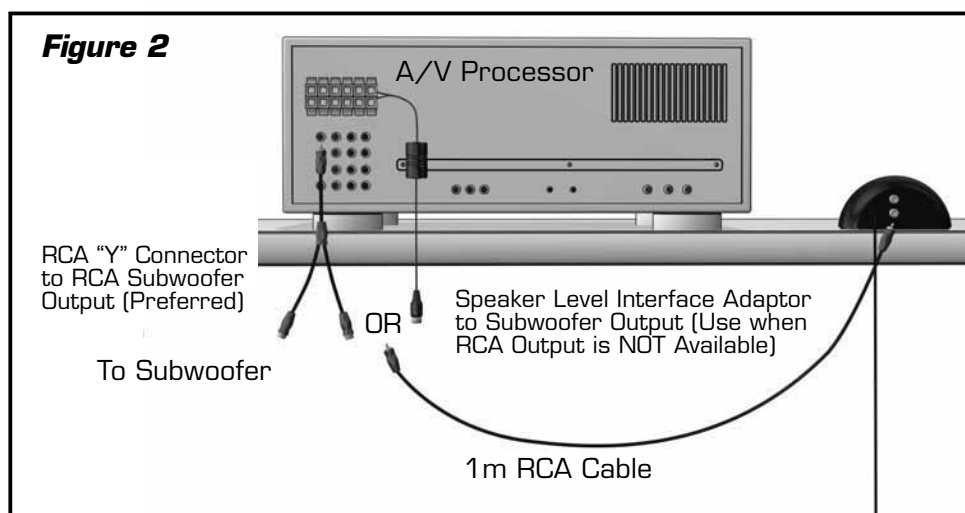

Amplifier Setup

RF Receiver / Transmitter Wireless Connection Setup

The RF Transmitter and RF Receiver link to each other using a randomly generated address. Once the Amplifier, RF Transmitter and RF Receiver have been properly set up per Steps 1 and 2, then do the following:

- a) Press once the recessed button located next to the LED on the RF Receiver **(See Figure 3 - pg 10)**. The LED will start blinking quickly showing that the RF Receiver is ready to connect to an RF Transmitter.
- b) Press once the recessed button located on the bottom of the RF Transmitter **(See Figure 4 - pg 10)**. The LED will start flashing quickly. If connection has been successfully established the LED on both RF Receiver and RF Transmitter will stop blinking. If the RF units do not connect within 10 seconds, the RF Transmitter LED will start blinking slowly and the RF Receiver will continue to blink quickly. To retry the connection process, press the button of the RF Transmitter.

Note: If you already have one RF Transmitter and Receiver pair working and you are installing a second set, press the button of the RF Transmitter twice. This will prevent interference between the two systems.

Troubleshooting Note:

If the RF units do not connect within 10 seconds, the RF Transmitter LED will start blinking slowly and the RF Receiver will continue to blink quickly. To retry the connection process, press the button of the RF Transmitter.

Optional Base Stand Usage

The Amplifier can also be set in an upright, vertical position by placing it as shown in the optional Base Stand (included). **MAKE SURE THAT THE AMPLIFIER'S SIDE VENTS ARE EXPOSED AND ARE FACING UP ON THE TOP SIDE WHEN PLACING THE AMPLIFIER IN THE BASE STAND.**

Amplifier Setup

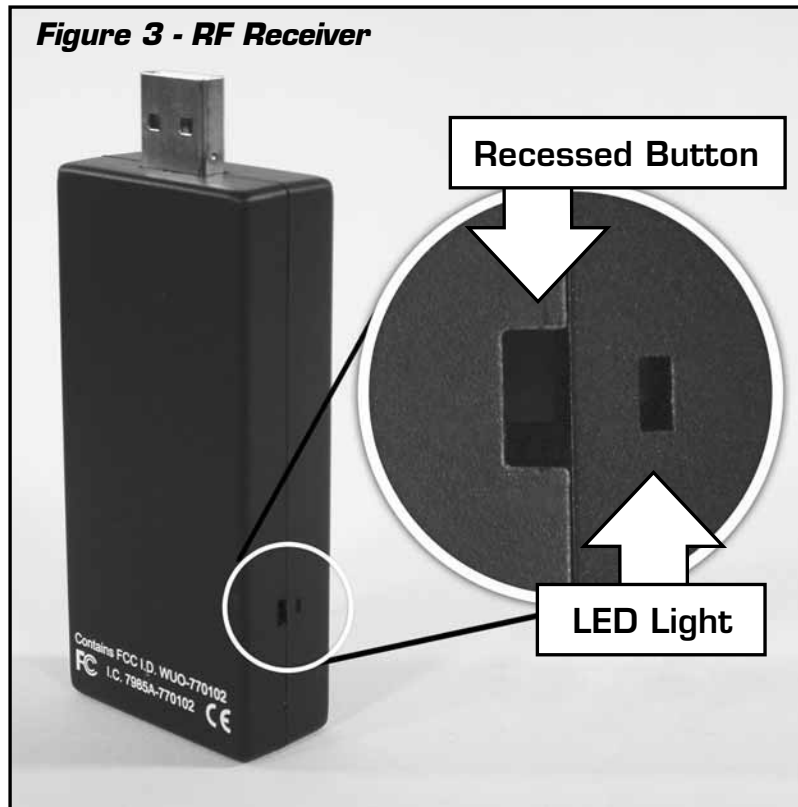

Figure 4 - RF Transmitter



Remote Control

Using the Remote Control

POWER BUTTON

Turn the Amplifier on or off using this button. See the “Power Status Indicator” section for the LED settings on the Amplifier.

INTENSITY

Remotely controls the output level of the Amplifier (i.e. the “volume” control). Set this to balance the ButtKicker® Advance with the sound system when using the Amplifier to power the ButtKicker® Advance.

PRESET EQ

Three optional preset “EQ” (equalizer) settings for changing how the Amplifier processes audio signals. (The names given do not necessarily reflect the optimal way to use the Amplifier for each type of media since each user will have his or her own settings preference.)

- “**Movie**” setting: Frequency response is flat with no filtering or cutoffs.
- “**Music**” setting: Set to +6dB increase of frequencies below 25 Hz with a frequency roll off of -12dB per octave above 100 Hz.
- “**Game**” setting: Set to -6dB reduction of frequencies below 25 Hz with a frequency roll off of -12dB per octave above 100 Hz.

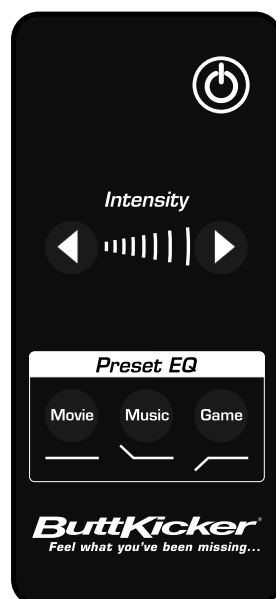



If you have questions or need technical support,
please contact The Guitammer Company, not
the store where you purchased the product.

The Guitammer Company

1-888-676-2828 / 1-614-898-9370

8:30 AM to 5:30 PM EST

Email us at:

support@guitammer.com

Visit us on the web at:

www.thebuttkicker.com

More Information

Visit www.thebuttkicker.com for support, FAQs, more information and details on other ButtKicker® brand products and accessories.

Limited Warranty

Your ButtKicker Power Amplifier BKA300-4 is warranted against failure for 1 YEAR unless otherwise stated. The Guitammer Company will service and supply all parts at no charge to the customer providing the unit is under warranty. Shipping costs are the responsibility of the customer. THE GUITAMMER COMPANY DOES NOT PAY FOR PARTS OR SERVICING OTHER THAN OUR OWN. A COPY OF THE ORIGINAL INVOICE IS REQUIRED TO VERIFY YOUR WARRANTY.

The Guitammer Company assumes no responsibilities for ButtKicker® low frequency audio transducers or speakers damaged by this unit. This warranty does not cover, and no liability is assumed, for damage due to: natural disasters, accidents, abuse, loss of parts, lack of reasonable care, incorrect use, or failure to follow instructions. This warranty is in lieu of all other warranties, expressed or implied. No representative or person is authorized to represent or assume for The Guitammer Company any liability in connection with the sale of servicing of products of The Guitammer Company. THE GUITAMMER COMPANY SHALL NOT BE LIABLE FOR INCIDENTAL OR CONSEQUENTIAL DAMAGES.

When RETURNING merchandise to The Guitammer Company, you may call or email for a return authorization number. Describe in writing each problem. If your unit is out of warranty, you will be charged the current FLAT RATE for parts and labor to bring your unit up to factory specifications.



THE GUITAMMER COMPANY

...leaders in low frequency sound...

ButtKicker®

Feel what you've been missing...